

SAFETY AND STORAGE INSTRUCTIONS

Before you do any step please read carefully all safety and storage instructions of all products and machines recommended by Pollmeier. All safety and storage instructions of the products' and machines' manufacturer must be followed.

Liquid Wax Cleaner

- _ 1 liter can: Keep out of the reach of children. In case of contact with eyes, flush thoroughly with water immediately and seek medical help. Ensure proper ventilation during work. The product is igniting.
- _ 0,4 liter spray can: The container is under pressure and must be protected from sunlight and temperatures over 50 °C (122 °Fahrenheit). Even after use do not open by force, tap or burn. Do not spray against flame or incandescent item. Keep away from ignition sources. Do not smoke. Do not inhale the aerosol. Use only in well-ventilated areas. Gas: propan/butan. The product is highly-igniting. Give only completely empty cans to recycling.

Stain

Should be stored at a temperature between 5 and 30 °C (41 and 86 °Fahrenheit), and must be kept away from heat sources, direct sunlight, and ignition sources.

Hardwax-Oil 3054

Keep out of the reach of children. In case of contact with eyes, flush thoroughly with water immediately and seek medical help. Do not work near an open flame. Product contain 2-butanone, which may produce allergic reactions. Cloths, polishing pads, floor brush or brush which have been soaked with the liquid product must be washed out or kept in an air-tight container after use, since they otherwise present a danger of spontaneous combustion.

Three-Disc Floor Buffing Machine

Please observe the safety instructions of the machine's manufacturer. Always empty the machine's dust bags immediately after finishing work due to the possible danger of spontaneous combustion.

Cleaning of the Tools

All tools can be cleaned with benzene-free Osmo® Brush Cleaner or mineral spirits.

Warranty disclaimer

No warranty exists with respect to Pollmeier's wood products, except for manufacturing defects. Pollmeier offers a limited warranty for its finish and does not offer a warranty for its hardwax-oil finish. Pollmeier warrants that its finish will be free from defects in material or manufacture. Pollmeier warrants its floor finish for 25 years under normal residential traffic conditions and 3 years under light commercial conditions, as described in Pollmeier's website. Pollmeier's warranty is applicable only to the original owner of its prefinished wood products. Pollmeier's warranty is limited to providing the original owner with repair, refinish, or replacement of the finish, at Pollmeier's sole discretion. For further information and up to date information regarding Pollmeier's warranty disclaimers, exclusions, installation instructions and requirements, and conditions, please visit www.pollmeier-flooring.com

CLEANING AND FLOORCARE

With proper attention to cleaning and maintenance, a natural wood floor can be enjoyed for many years.

Special care is required for heavily used natural floors in restaurants, offices, department stores or public buildings to ensure long-lasting, beautiful floors. Protective steps such as using felt pads under chairs and other furniture in order to avoid scratches, as well as floor mats for wheelchairs, is worthwhile. The cleaning and maintenance intervals in areas such as these should be more frequent than in the home.

Daily cleaning can be done with a broom, a vacuum cleaner or with a commercially available dust mop.

For damp cleaning, we recommend Osmo® Wash and Care. Areas of heavy traffic, as described above, should be damp cleaned daily. In the home, it is sufficient to apply Wash and Care once a week.

Please note: Wood floors must be damp wiped, not wet wiped. A commercially available mop is also ideal for this purpose.

To remove any stubborn spots you can use the Wax Cleaner 3029. Simply apply the cleaner using a cloth or buffing pad, rub the floor and wipe up the dissolved dirt.

Before a floor completely loses its shine it can be refreshed using Liquid Wax Cleaner 3029. Just apply the cleaner undiluted with a lint-free cloth onto the cleaned floor and spread extremely thinly (2 teaspoons per 10 sqft/1 m² is enough). For larger surfaces, a commercially available active fiber cloth would be suitable. In restaurants this application is recommended as much as once a week; otherwise floors should be refreshed as needed.

RE-OILING BAUBUCHE FLOORING WITH OSMO® HARDWAX-OIL 3054*

If there are visible signs of wear, which are not serious enough to require sanding the surface, the floor should be re-treated with Osmo® Hardwax-Oil 3054. When and how often a floor finished with Osmo® Hardwax-Oil must be re-oiled depends, for one, on how much traffic this natural floor is exposed to, and for another, on how regularly the floor is cleaned and maintained. One factor that makes re-oiling the floor necessary is the appearance of wear in areas of heavier traffic.

Private Households and Smaller Areas

- The area of the floor you want to oil must first be thoroughly cleaned, dried, and free of dust.

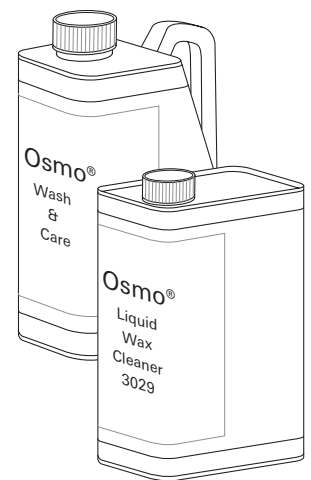

Danger!

Harmful or fatal if swallowed. Call physician immediately if ingested.

Caution

Flammable/Combustible. Keep away from open flame and other ignition sources.

Caution

May cause respiratory tract irritation. May cause skin irritation. May cause eye irritation. Avoid contact with eyes, skin and clothing. Read carefully and follow instructions on package.



* Osmo® Hardwax-Oil is not a product of Pollmeier.

– Osmo® Hardwax-Oil 3054 is applied with a floor brush, or a stiff, densely-packed natural-hair brush, onto the clean and dry wood surface. Then spread **thinly** and thoroughly in the direction of the grain of the wood. Ensure that the oil is always applied thinly and cleanly. Remove any excess with a lint-free cloth. Let the oiled floor dry for 12 hours at 20 °C (68 °Fahrenheit) ensuring proper ventilation. Always follow manufacturer instructions on the product label.

– Repeat step 2. The floor can be walked on again after being allowed to dry for 12 hours at 20 °C (68 °Fahrenheit) ensuring proper ventilation. High levels of humidity may result in longer than normal drying time.

Note: The finish is not completely cured until 10 to 14 days after application. During this curing phase you should not put down any carpeting or, as in the course of upkeep, apply any dampness to the surface. Cover areas of heavy traffic with corrugated cardboard, with the corrugated side facing the floor to permit better ventilation.

Commercial and Public Use Areas

– The area of the floor you want to oil must first be thoroughly cleaned, dried, and free of dust.

– Osmo® Hardwax-Oil 3054 is applied with a floor brush or a stiff, densely-packed natural-hair brush, onto the clean and dry wood surface. Then spread the applied oil evenly across the surface with a Lägler Trio three-disc floor buffing machine*, or an equivalent spreading machine, outfitted with three white polishing pads without any grit.

– Remove polishing pads and fit the brush heads onto the appropriate receptacles on the machine. The rotating brushes allow the oil to penetrate all the depressions as well as the bevels along the lengths and the ends of the boards and spread any puddles evenly over the floor. Let the oiled floor dry for 12 hours at 20 °C (68 °Fahrenheit) ensuring proper ventilation.

– Repeat steps 2 and 3. The floor can be walked on again after being allowed to dry for 12 hours at 20 °C (68 °Fahrenheit) ensuring proper ventilation. High levels of humidity may result in longer than normal drying time. Once the floor is properly dried, it is generally inflammable.

Note: The finish is not completely cured until 10 to 14 days after application. During this curing phase you should not put down any carpeting or, as in the course of upkeep, apply any dampness to the surface. Cover areas of heavy traffic with corrugated cardboard, with the corrugated side facing the floor to permit better ventilation.

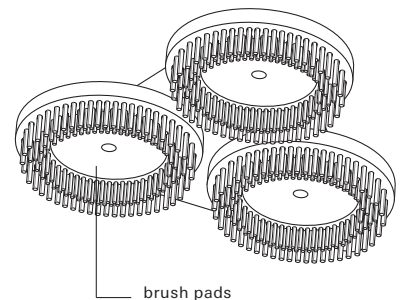
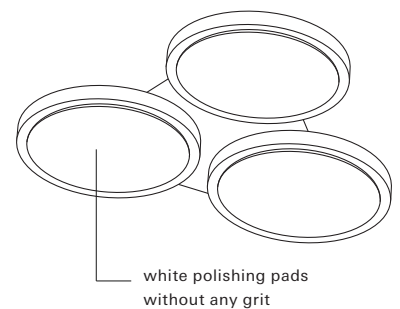
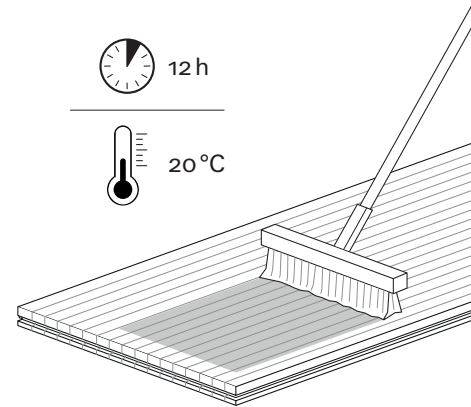

* This is not a Pollmeier product

PERFORMING MINOR REPAIRS TO STAINED AND HARDWAX-OILED BAUBUCHE FLOORING

- _ Sand the spot you would like to repair using a sanding sponge with 180-grit to restore it to the raw wood surface. Smooth out any roughness created by the 180-grit paper in the area surrounding the spot to be repaired using 400-grit paper.
- _ Apply stain with a cloth directly on the prepared surface and allow sufficient time for the stain to dry. Wipe the stained surface with a damp cloth and ensure color uniformity. If the tone is too light, repeat with another application until a match is achieved.
- _ When the color match is achieved apply Osmo® Hardwax-Oil 3054 with a clean cloth to the stained area, let it dry for 12 hours at a temperature of 20 °C (68°Fahrenheit) ensuring proper ventilation.
- _ Once properly dried, apply Osmo® Hardwax-Oil 3054 with a cloth for a second time. If you are not fully satisfied with the result, the process may be repeated.
- _ The floor can be walked on again after it has dried for 12 hours at 20 °C (68°Fahrenheit) ensuring proper ventilation. High levels of humidity may result in longer drying time. Once the area is properly dried, it is generally inflammable.

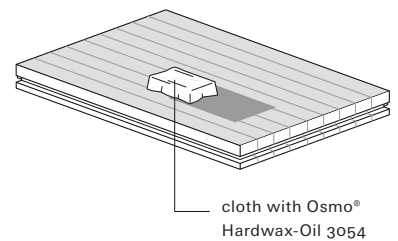
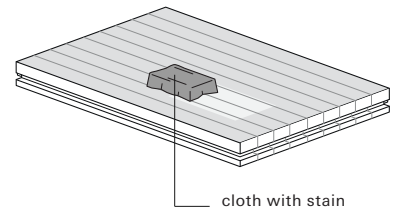
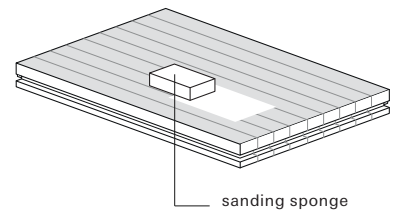

Note: The finish is not completely cured for 10 to 14 days after the repair was performed. During this curing phase it is unadvisable to lay carpeting on the area or apply any damp material (including mopping) on the repaired surface. Cover areas of heavy traffic with corrugated cardboard, with the corrugated side facing the floor to permit better ventilation.

COMPLETELY SANDING AND RE-OILING BAUBUCHE FLOORING USING OSMO® HARDWAX-OIL 3054

During the application process be sure to follow all product-handling instructions contained on the on the product label.

The right amount of smoothness is the basic prerequisite for how the surface will look later. You can achieve this by sanding from rough to fine, and from large to small. Whenever possible, you should always sand in the direction of the wood grain. Depending on the damage to the surface you can start with the Lägler Trio three-disc floor buffing machine, or an equivalent spreading machine, outfitted with three 80-grit sandpaper discs.

Areas of the floor that are inaccessible with the Lägler Trio can be sanded using the Lägler Flip or an equivalent sanding machine designed to sand along edges.

The second and third sanding should be done with 100-grit or 120-grit paper.

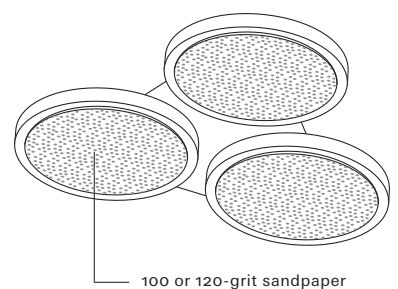
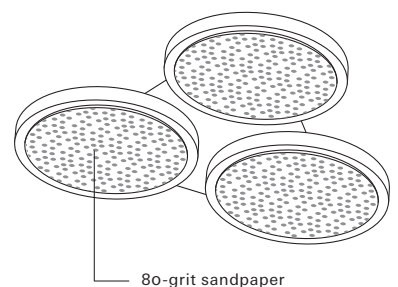

After the third sanding, we recommend mending any knots, cracks or defective spots with wood filler. The wood filler can be applied with a putty knife and can be sanded down after it has dried for the time period specified by the manufacturer.

The final sanding is done in the same way, but with 150-grit paper.

The wood floor must be completely clean and free of sanding dust before any further work is carried out.

Apply the first coat of Osmo® Hardwax-Oil 3054. Osmo® Hardwax-Oil 3054 is applied with a floor brush, or a stiff, densely-packed natural-hair brush, onto the clean and dry wood surface. Spread **thinly** and thoroughly in the direction of the grain of the wood. Ensure that the oil is always applied thinly and cleanly. Remove any excess with a lint-free cloth.

Let the oiled floor dry for 12 hours at 20 °C (68 °Fahrenheit) ensuring proper ventilation.

Apply the second coat of Osmo® Hardwax-Oil 3054. Apply Hardwax-Oil 3054 as described above with the floor brush or a stiff, densely-packed natural-hair brush. Then spread the applied oil evenly across the surface with a Lägler Trio three-disc floor buffing machine or an equivalent spreading machine outfitted with three white polishing pads without any grit.

Remove the polishing pads and fit the brush heads onto the appropriate receptacles of the machine. The rotating brushes get into all the depressions as well as the joints along the lengths and the ends of the boards and spread any puddles evenly over the floor. The floor can be walked on again after it has dried for 12 hours at 20 °C (68 °Fahrenheit) and with plenty of ventilation. If the humidity is high, the drying process may take longer.

Note: The finish is not completely cured until 10 to 14 days after application. During this curing phase you should not put down any carpeting or, as in the course of upkeep, apply any dampness to the surface. Cover areas of heavy traffic with corrugated cardboard, with the corrugated side facing the floor to permit better ventilation.

FURTHER INFORMATION

There are several videos in our media centre on www.osmo.de, providing useful information about the various OSMO® products. The menu item "wood coatings, indoor" features up-to-date information on the various wood care products.

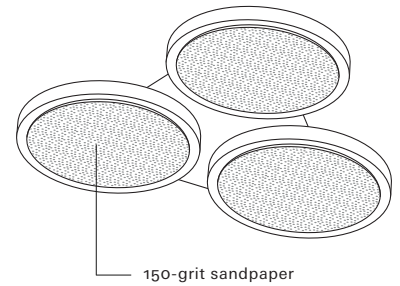

© Pollmeier Leimholz GmbH,
Rüschfeld 131, 33397 Rietberg, Germany
Errors and misprints reserved